

Quality Connection

Dedicated to Quality Kia Vehicle Repairs

SUMMER 2017 VOL. 12 | NO. 2



2017 SOUL TURBO

[Models may vary]

www.kia.com

A REMOTE POSSIBILITY

Blown fuse may lead to remote harness replacement

POWER OUTAGE

Sliding door may need a new remote controller actuator

TIMING IS EVERYTHING

When it comes to replacing a timing belt



Genuine Parts

It's a family affair

Major magazine names 2 Kias "best cars for families"

Kia prides itself on building family-friendly vehicles. Apparently, *U.S. News & World Report* agrees because it recently named the Soul and Cadenza as two of its "2017 Best Cars for Families." Moreover, the Soul also received the award last year.

According to the *U.S. News* website, choosing the right family car is about "striking a balance." Addressing its methodology, it says, "Each of the award winners have the best combination of positive reviews from professional car critics, safety ratings, space, and available tech features."

Emphasizing the tech point, the *U.S. News* website also says, "All of the winners have available advanced driver assistance features, like blind spot warning, forward collision warning, and automatic braking, to help prevent a collision."

Orth Hedrick, vice president, product planning for Kia Motors America, says that Kia is thrilled with the awards "because they speak to the effort we put into creating vehicles that families will love. It's part of Kia's global commitment to offer attractive, reliable and dynamic vehicles with tremendous value." He



The Kia Soul has been awarded two years in a row.

concludes, "Being awarded Best Cars for Families by *U.S. News & World Report* is testimony to those efforts and we couldn't be more proud."

The Soul was noted for outstanding ergonomics and tech features. "The ride height is neither too low nor too high, making it easy for both little kids and grandparents with limited mobility to get in," says *U.S. News* Autos managing editor Jamie Page Deaton. "Parents of teen drivers can get some peace of mind with the Soul's UVO system, while Apple CarPlay™ and Android Auto™ keep families connected with limited distraction on the road."¹

As for the Cadenza, Page Deaton says that the same luxury features that are attractive to adult drivers are meaningful for families. "Rear sunshades keep backseat passengers cool so they can ride or nap in peace." And as with the Soul,

she emphasizes the practicality of Kia's advanced car technology for the Cadenza. "UVO teen-driver controls make it easier to hand the keys over to new drivers, and Apple CarPlay™ and Android Auto™ make it easier to access common smartphone functions without having to learn a new operating system."

At some point, you may see Kia Souls and Cadenzas in your shops. For best results in serving them, we recommend keeping things "all in the family" by using Genuine Kia Parts to service and repair them.

Kia Motors America, Inc.

All trademarks and tradenames are the property of their respective owners. 2017 Kia Soul Turbo shown on the cover and above with optional features. Not all optional features are available on all trims. Some features may vary.

¹ Warning: Driving while distracted can result in a loss of vehicle control that may lead to an accident, severe personal injury and death. Always drive safely and use caution.

IN THIS ISSUE

VOL. 12 | NO. 2 SUMMER 2017 | *Quality Connection* is published by Kia Motors America



4

A remote possibility

Blown fuse may lead to remote harness replacement



8

Power outage

Sliding door may need a new remote controller actuator

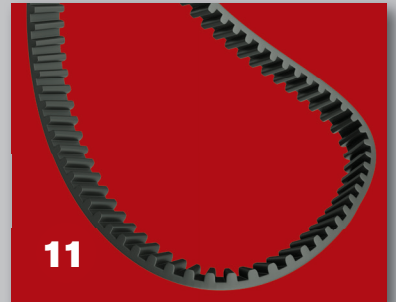

11

Timing is everything

When it comes to replacing a timing belt

A Genuine Part of You.



When your customers are behind the wheel,
Kia is more than just the sum of its parts.

Your customers and Kia are built for each other, and Genuine Kia replacement parts bring the superior quality and fit that they've come to expect. Backed by the Kia warranty,* **Genuine Kia Parts** and **Genuine Kia Remanufactured Parts** give added confidence on the road. Customers work hard, Genuine Kia Parts work even harder."



Genuine Parts

* Kia Genuine replacement parts (except battery) sold by an Authorized Kia Dealer under warranty are covered for the greater of (1) the duration of the New Vehicle Limited Warranty or (2) the first 12 months from the date of installation of the Kia Genuine replacement parts or 12,000 miles. Labor charges not included when not installed by an Authorized Kia Dealer. Warranty is limited. See Kia's Replacement Parts and Accessories Limited Warranty for further details.

A remote possibility

Blown fuse may lead to remote harness replacement

 As an automotive technician servicing Kia vehicles, you may encounter a 2011/2012 Sorento vehicle in which the heater/blower motor is not functioning when the remote start is used. This issue may be caused by a blown 15 amp HVAC1 fuse located within the remote start module. Follow the remote harness removal and replacement procedure in this article to remedy the issue. (Note: The replacement harness utilizes a load reduction design.)

» **NOTICE:** This procedure should only be conducted if a customer has a specific issue with RES, i.e., that the HVAC fuse blows in the RES module, otherwise this procedure is not required.

» TSBs may be updated from time to time. Please refer to TSB EL 016 at www.kiatechinfo.com for the latest procedures.

» All images are for illustration purposes only.

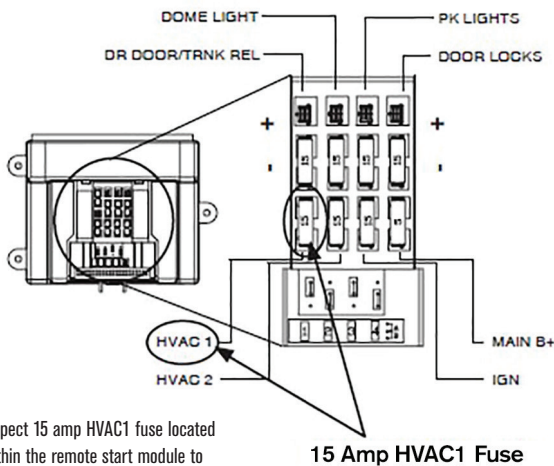

Inspect 15 amp HVAC1 fuse located within the remote start module to determine if it is good.

AFFECTED VEHICLE PRODUCTION RANGE

Model	Production Range
Sorento (XM)	MY range 2011-2012

REQUIRED PARTS

Part Name	Part Number	Figure
Remote Start Harness Kit	U8561 1U002	



Remote harness removal service procedure

1. Before starting service procedure: Record radio station presets and disconnect negative battery terminal.
2. Remove the driver's side front door step sill trim by inserting the trim removal tool under the trim panel and carefully prying upward to release the four push clips.
3. Carefully pull the weatherstrip away from the side of the driver's side kick panel as indicated in the photo. Then remove the following: the hood release lever by pulling toward the center of the vehicle; the plastic nut located near the vehicle dash wall, if equipped; and the driver's side kick panel from the vehicle by pulling upward to release the push clip and prying toward the center of the vehicle to disengage the two clips. Remove the driver's side dash end-cap panel by prying outward to disengage the four clips.
4. Remove the lower-dash finish panel by removing the four Phillips screws from the bottom of the panel. Using a trim removal tool, carefully pry outward to release the five clips. Remove the OBDII connector from the panel. Disconnect the remaining connectors, if equipped.



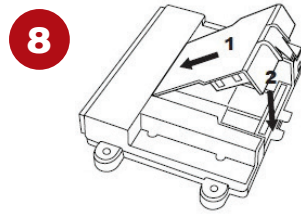
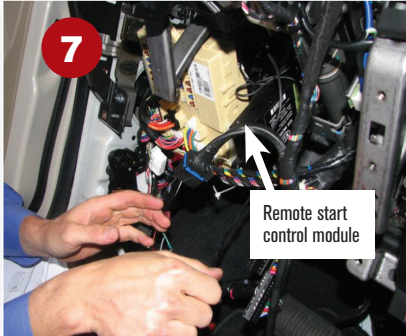

Caution: Be careful not to bend the mating pins of the multi-pin connector when installing the DNA card.

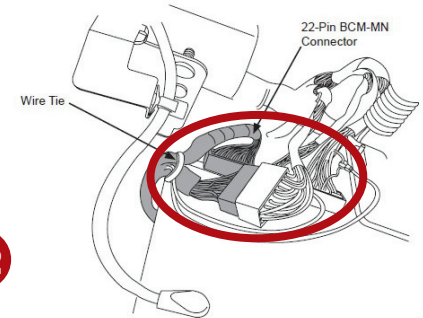
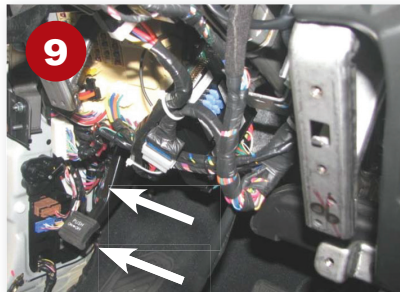
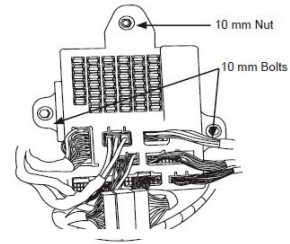
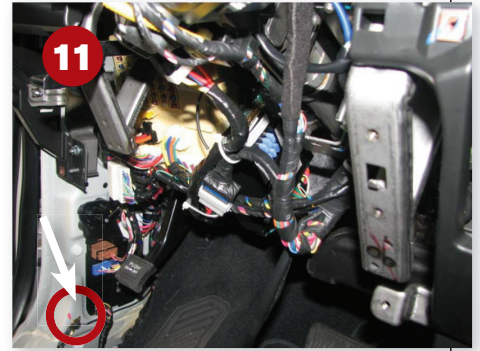
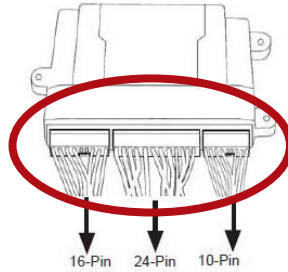

5. Remove the five 10 mm hex bolts and one 10 mm hex nut securing the steel knee bolster panel as indicated by the arrow. Remove the steel knee bolster panel from the vehicle and set aside.

6. Remove the three Phillips screws securing the steering column shroud (one underneath and two behind the steering wheel). Turn the steering wheel for access. Pull down to separate (use trim tool, if necessary) and remove the lower steering column shroud from the vehicle.

7. Locate the remote start control module mounted to the factory brace supporting the fuse box. Remove the existing DNA Module by pressing the tab at the back of the DNA Card and then lifting the DNA card from the back side.

8. Remove and inspect the 15 amp HVAC1 fuse to determine if it is good; replace it,



if necessary. Install the DNA card into the remote start control module. Press the center release tab on each connector to disconnect all three wire harness connectors from the remote start control module.

9. Cut the two small wire ties securing the Black ground wire to the existing factory harness. Arrows in the photo indicate the general location of the wire ties. Cut the three large wire ties (arrows) securing the remote start harness.

10. Cut the one large wire tie securing the remote start harness to the existing factory harness. Cut the three small wire ties securing the disarm/programming button to the remote start harness.

11. Locate and remove the 10 mm hex ground bolt in the left kick panel area. Remove the remote start harness Black ground wire with ring terminal from the bolt.

12. Notice: Remove the two 10 mm hex bolts, and the one 10 mm hex nut securing the fuse box, and then tilt it forward for better access to the BCM connectors. Cut the one small wire tie securing the Lt. Blue (Parking Light Output) wire, Yellow/Black (Driver Door Unlock Output) wire and the 22-pin male and female BCM-MN remote start harness connectors to the remote start wire harness. Disconnect the remote start harness 22-pin male and female connectors.

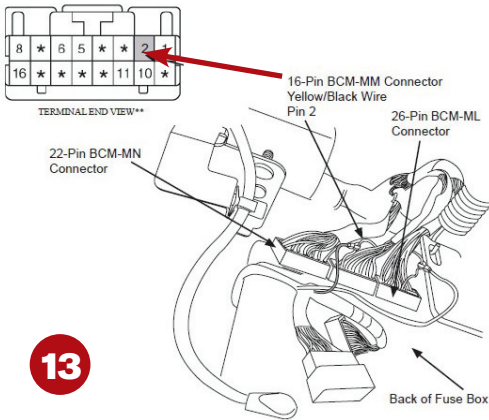

13

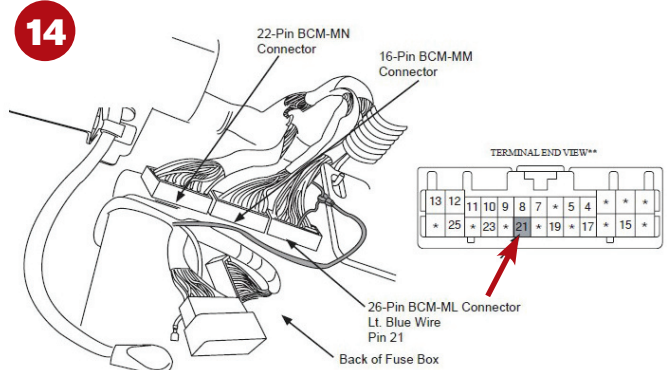

14



15

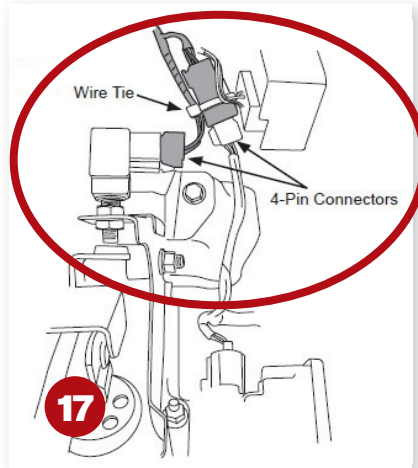

17

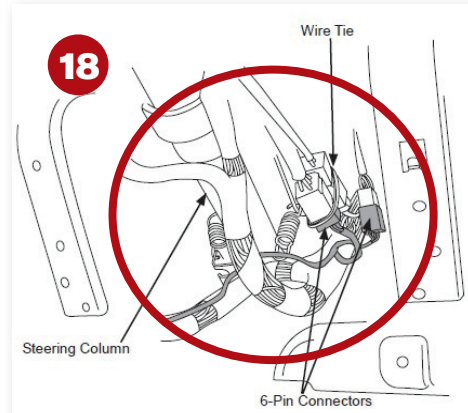

18

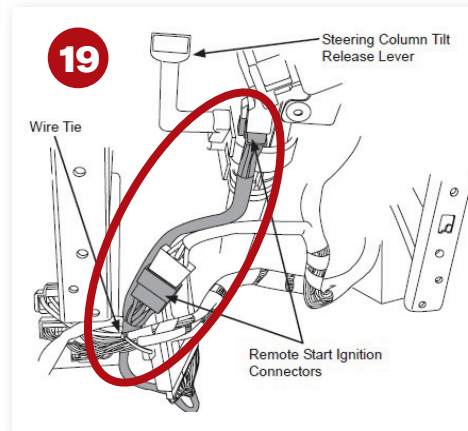

19

13. Disengage the 16-pin BCM-MM connector from the back side of the BCM, if necessary. Remove the remote start harness Yellow/Black (Driver Door Unlock Output) wire from the Yellow/Black wire (Pin #2 of the BCM-MM connector) by disengaging the T-Tap.

14. Disengage the 26-pin BCM-ML connector from the back side of the BCM, if necessary. Remove the remote start harness Lt. Blue (Parking Light Output) wire from the Lt. Blue wire (Pin #21 of the BCM-ML connector) by disengaging the T-Tap. Disconnect the remote start harness 26-pin male and female connectors at the front of the fuse box.

15. Remove the remote start harness Green/Orange (Tachometer Input) wire from the Green/Orange wire (Pin #26 of the I/P-E connector) by disengaging the T-Tap.

16. Remove the remote start harness Gray (Rear Defroster Output) wire from the Gray wire (Pin #17 of the I/P-F connector) by disengaging the T-Tap. Remove the remote start harness Red/Black (Hood Ajar Input) wire from the Red/Black wire (Pin #16 of the I/P-F connector) by disengaging the T-Tap.

17. Cut the one small wire tie securing the factory male CHG 39 brake switch connector and the remote start harness female brake switch connector to the remote start harness. Disconnect the remote start harness 4-pin male and female brake switch connectors.

18. Cut the one small wire-tie securing the factory male M37 key-in-sense connector and the remote start harness female key-in-sense connector to the factory connector. Disconnect the remote start

harness 6-pin male and female key-in-sense connectors.

19. Cut the one large wire-tie securing the left side of the remote start module to the factory wire harness. Disconnect the remote start harness 6-pin male and female ignition switch connectors. Remove remote start harness from vehicle.

Remote start harness installation (T-Tap installation procedure)

Factory wire harness colors are subject to change, please use the specified pin # in the harness connector to identify the correct wire for T-Tap installation.

Only perform the following procedure if a T-Tap was removed during harness removal:

- Place T-Tap on vehicle wire;
- using pliers, close and crimp T-Tap around vehicle wire; and
- insert harness wire with male spade terminal and into T-Tap.

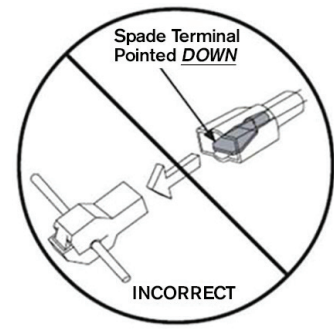
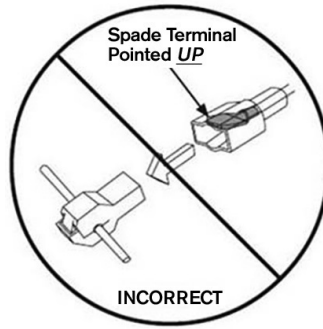

CORRECT
Spade terminal **CENTERED** inside connector

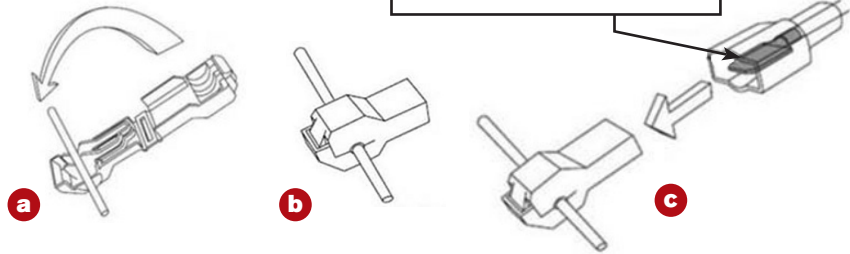

Extreme care must be taken to ensure that the male spade terminal is inserted in the T-Tap properly.

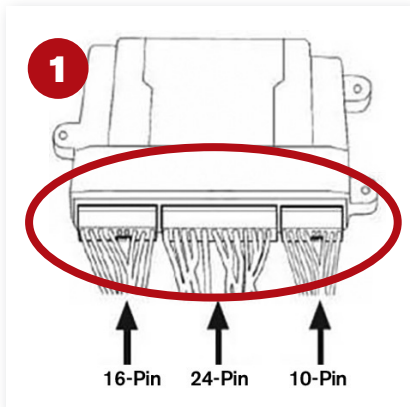

1. Plug the wire harness connectors into the remote start module before mounting. Ensure all connectors are properly locked into position.

2. Route the remote start harness 6-pin male and female ignition connectors upward to the ignition switch. Connect the male 6-pin M15 ignition connector and plug in the corresponding remote start harness connectors.

3. Route the remote start harness 6-pin male and female key-in sense connectors along the factory harness toward the factory 6-pin connector, located to the right of the steering column.

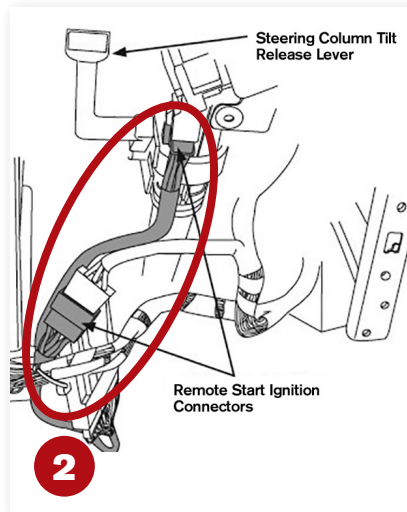

Connect the male 6-pin M37 connector and plug in the corresponding remote start harness connectors.

4. Route the remote start harness 4-pin male and female brake switch connectors under the steering column to the brake switch. Connect the male 4-pin CHG 39 connector and plug in the corresponding remote start harness connectors. Secure the factory male connector and the remote start harness female connector to the remote start harness with one small wire tie. Trim off excess wire tie.

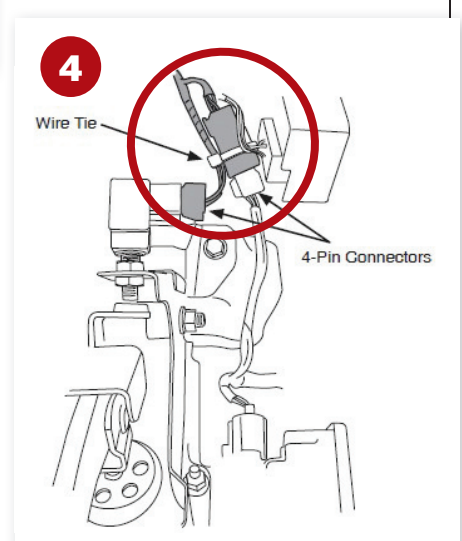
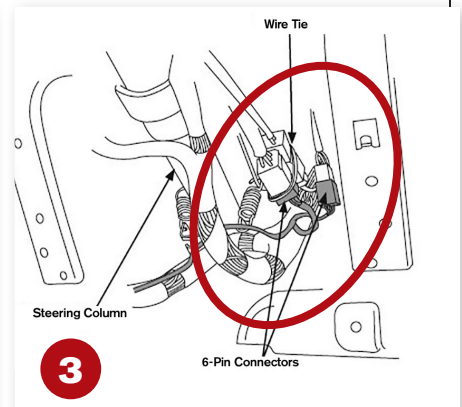



5

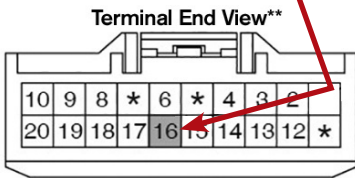

5. Route the 26-pin male and female connectors, Red/Black and Gray wires toward the fuse box. Attach the Red/Black wire to the #16 pin of the 20-pin I/P-F male connector. If Removed: Using pliers, crimp a T-Tap on the Red/Black wire located in pin #16 of the I/P-F male connector. Connect the Red/Black (Hood Ajar Input) wire from the remote start harness to the Red/Black wire (Pin #16 of the I/P-F connector) by engaging the T-Tap.

6. Attach the Gray wire to the pin #17 pin of the 20-pin I/P-F male connector. If Removed: Using pliers, crimp a T-Tap

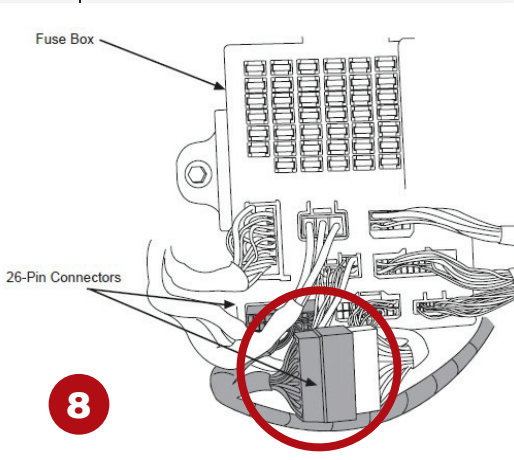

8

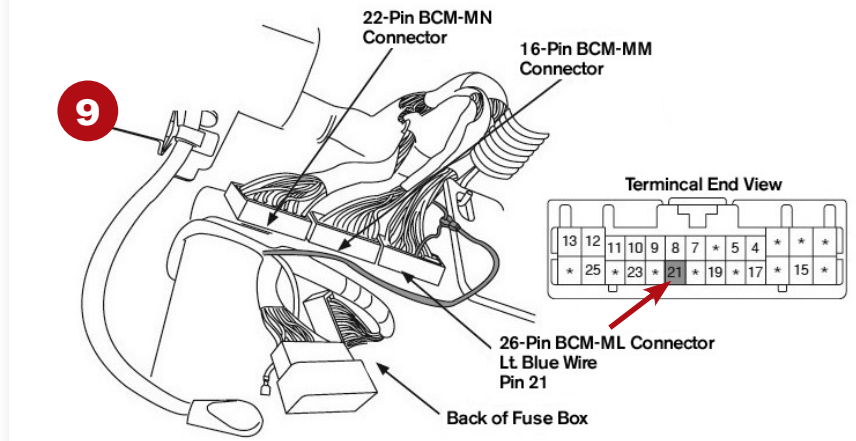

10

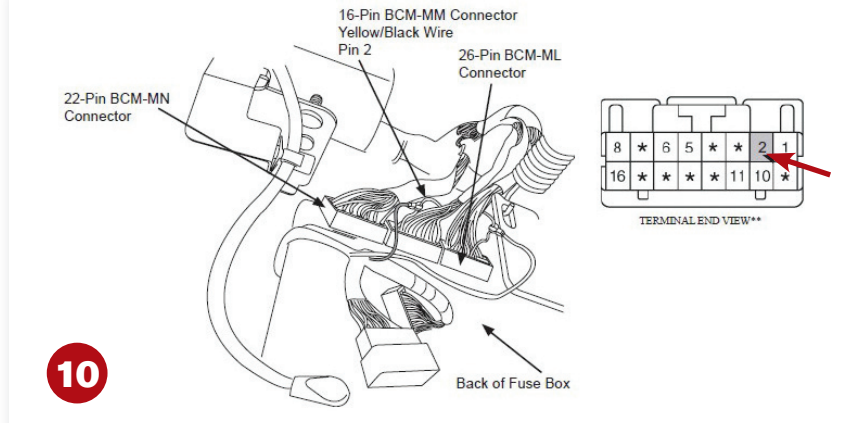

on the Gray wire located in pin #17 of the I/P-F male connector. Connect the Gray (Rear Defroster Output) wire from the remote start harness to the Gray wire (Pin #17 of the I/P-F connector) by engaging the T-Tap.

7. Attach the Green/Orange wire to the #26 pin of the 26-pin I/P-E male connector. If Removed: Using pliers, crimp a T-Tap on the Green/Orange wire located in pin #26 of the I/P-E male connector. Connect the Green/Orange (Tachometer Input) wire from the remote start harness to the Green/Orange wire (Pin #26 of the I/P-E connector) by engaging the T-Tap.

8. Connect the factory male 26-pin BCM-FK connector at the fuse box and plug in the corresponding remote start harness connectors.

9. Route the portion of the remote start harness containing the Yellow/Black wire, Lt. Blue wire and the 22-pin male and female connectors along the right side of the fuse box to the BCM (located on the back side of the fuse box).

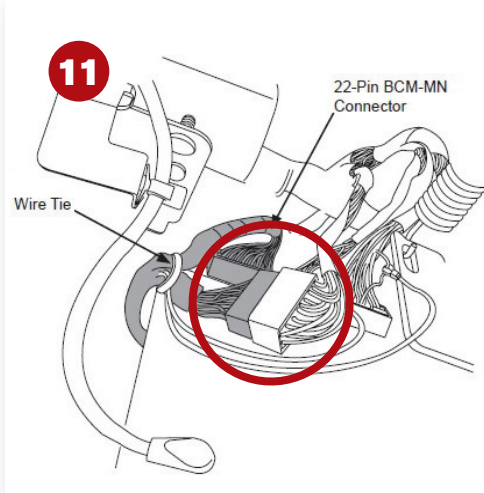

11

Locate the Lt. Blue wire in pin #21 of the 26-pin BCM-ML male connector. If Removed: Using pliers, crimp a T-Tap on the Lt. Blue wire located in pin #21 of the BCM-ML male connector.

Connect the Lt. Blue (Parking Light Output) wire from the remote start harness to the Lt. Blue wire (Pin #21 of the BCM-ML connector) by engaging the T-Tap. Engage the 26-pin BCM-ML connector from the backside of the BCM.



10. Locate Yellow/Black wire located in pin #2 (arrow) of the BCM-MM connector. Using pliers, crimp a T-Tap on Yellow/Black wire. Connect the Yellow/Black (Driver's Door Unlock Output) wire from remote start harness from the Yellow/Black wire (pin #2 of BCM-MM connector) by engaging T-Tap.

11. Connect the factory male 22-pin BCM-MN connector at the BCM and plug in the corresponding remote start harness connectors. Secure the Lt. Blue (Parking Light Output) wire, Yellow/Black (Driver Door Unlock Output) wire and the 22-pin male and female BCM-MN remote start harness connectors to the remote start wire harness with one small wire tie. Trim the wire tie.

12. Route the Black wire with ring terminal down along the factory wire harness to the factory ground location. Install 10 mm hex bolt. Position the Black wire with ring terminal over the bolt and reinstall with factory ground wires.

13. Connect the disarm/programming button to the corresponding remote start module connector (if disconnected). Secure the disarm/programming button to the remote start harness with three small wire ties. Trim off excess wire ties. Ensure disarm/programming button is secured to the remote start harness in a

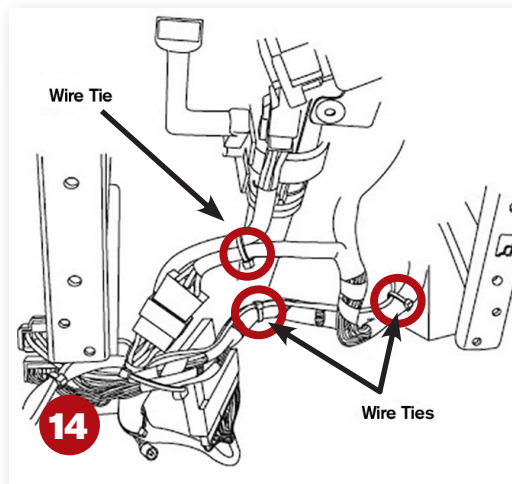
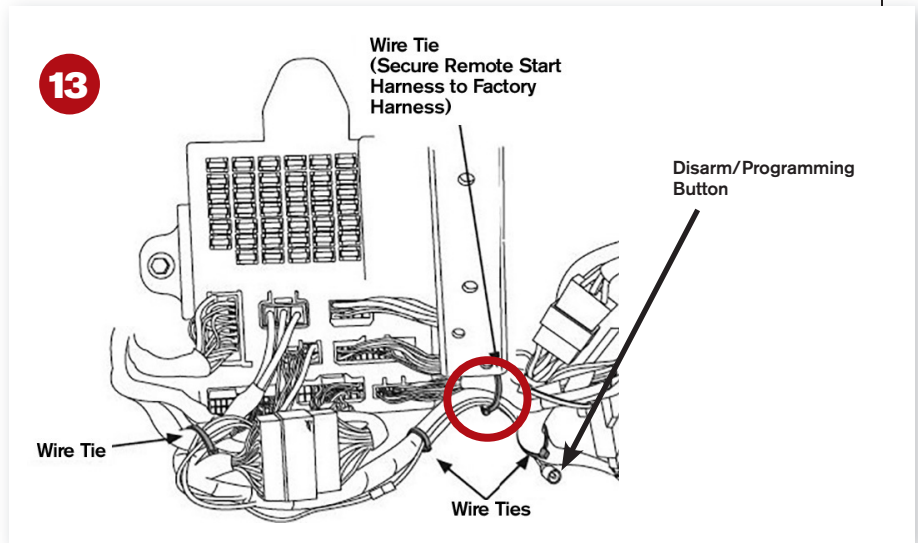

manner that allows for future serviceability. Secure the remote start harness to the existing factory harness with one large wire tie. Trim the wire tie.

14. Secure the remote start harness with three large wire ties. Trim off excess from wire ties.

15. Secure the Black ground wire to the existing factory harness with one small wire tie. Trim the wire tie.

16. Verify all connections are secure as per the installation instructions. Turn the ignition key to the ON position. Reconnect the negative battery cable. If the horn begins sounding, press the disarm/programming button with the ignition ON to disarm the system. Battery cable terminal torque spec: 3.6 lb-ft +/- .7 lb-ft (5 Nm +/- 1 Nm)

Start the vehicle with the key and



verify that no Diagnostic Trouble Codes have been triggered. Any DTCs should be reset before proceeding to the next step. Turn the ignition key to the OFF/LOCK position. Reinstall all interior components (steps 1-7 of removal procedure) in the reverse order of removal. Check remote start function. **KIA**

Power outage

Sliding door may need a new remote controller actuator

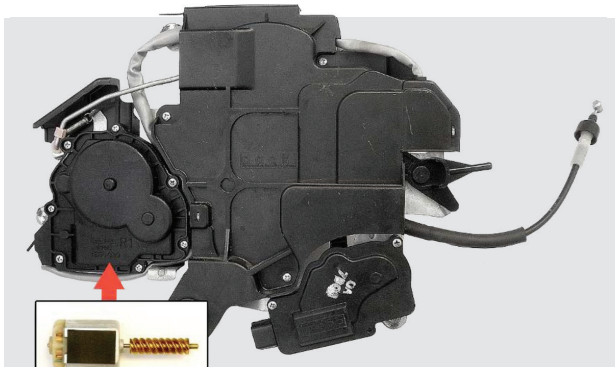

Power Sliding Door Remote Controller Assembly
P/N 81447 4D500 Actuator Motor Shown Externally

AFFECTED VEHICLE PRODUCTION RANGE

Model	Production Range
Sedona (VQ) with Power Sliding Door Options	All MY 2006 -2010 Sedona (VQ)

REQUIRED PARTS

Part Name	Part Number	Figure
Remote Controller Motor	Part Number 81447 4D500	

» TSBs may be updated from time to time. Please refer to TSB BOD 048 at www.kiatechinfo.com for the latest procedures.

» All images are for illustration purposes only.



You may come across a Sedona (VQ) that has a power sliding door (PSD) that won't open when using the overhead console switch, B pillar switch or remote control button. If you do, the PSD Remote Controller Actuator may need to be replaced (on the affected side only) with Part Number 81447 4D500. Note: Do not replace the Remote Controller Assembly for this issue.

Disassembly procedure

1. If it is determined that the power sliding door remote controller motor is defective, follow the instructions provided in Kia's Global Information System (KGIS) to remove the door trim and controller assembly before bench repairing the controller unit. Removed PSD remote controller is shown here along with the location of release motor drive assembly.

2. Remove the seven screws holding the cover and drive assembly in place.

Notice: There are four short screws and three long screws. The longer screws attach the motor assembly to the controller.

3. Carefully separate the cover from the drive assembly as shown. Be especially careful not to damage or misplace the seal.

Notice: It is not necessary to remove the complete drive assembly from the remote controller.

4. While holding the motor in place, use small needle-nose pliers to carefully disconnect the wiring from the motor. The blade style connectors easily pull straight up and out.

Notice: Note the wire's color and position for reinstallation. If the wires are switched, the remote controller will not operate correctly.

5. Remove the motor from the drive assembly.

Notice: Be careful not to misplace the motor's white nylon end support bearing.

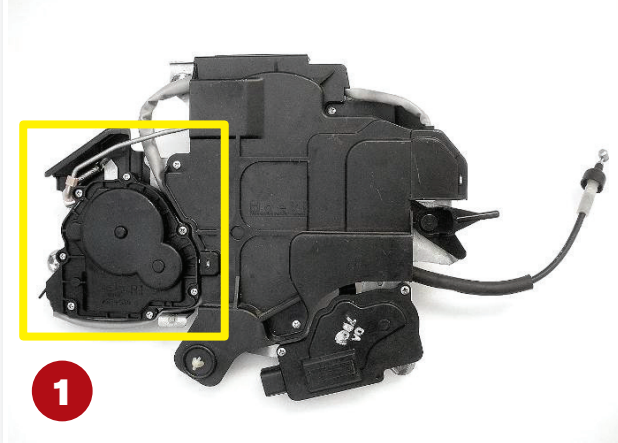

1

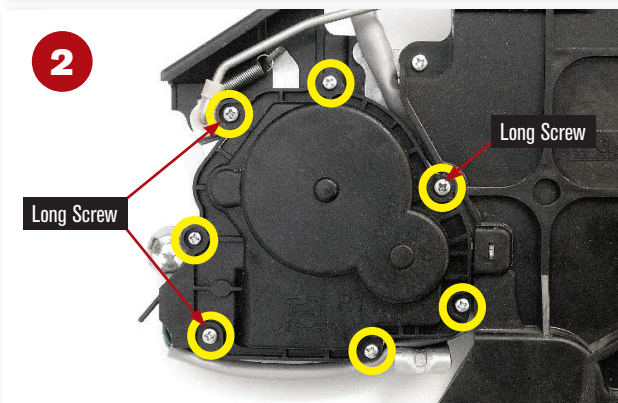

2

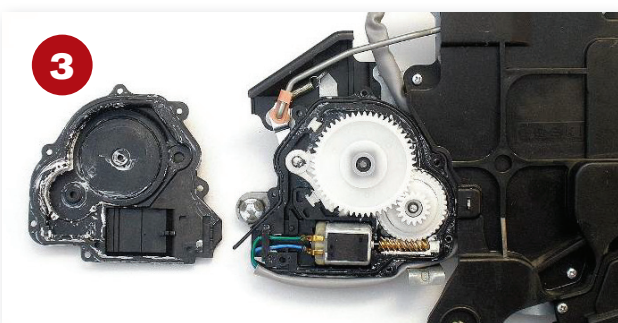

3

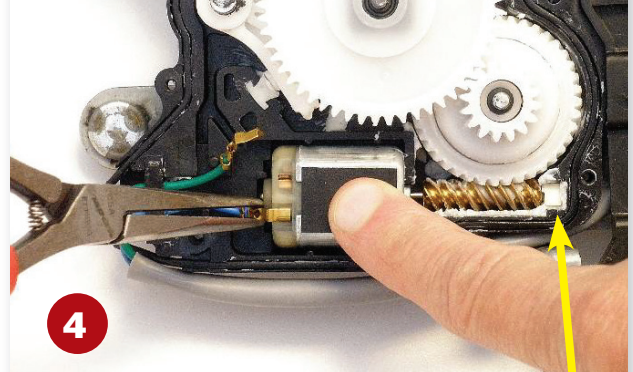

4

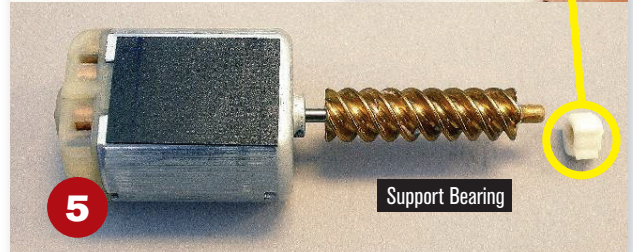

5

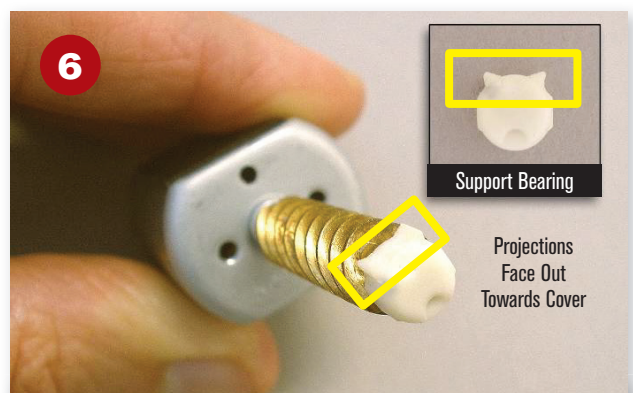

6

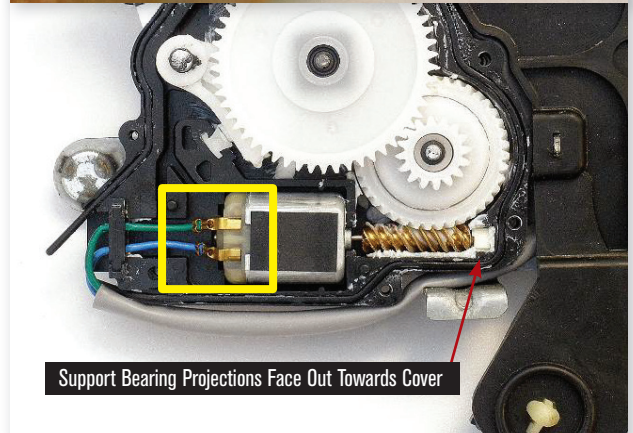

Support Bearing Projections Face Out Towards Cover

Installation procedure

6. Reinstall the motor making certain that the small nylon support bearing is properly installed as indicated above. Reinstall the wiring observing proper polarity, otherwise the drive assembly will not work properly.

Notice: While reinstalling the motor, make sure that the white nylon support bearing projections are facing out towards the cover. Failure to do this may result in noise and/or gear damage.

7. Reinstall the cover making sure the seal is properly in place, and that the proper length screws are installed in the proper positions. Do not pinch the wiring between cover and housing.

Notice: The shorter screws should be fully installed first, then the longer screws, as the longer screws both seal and attach the motor assembly to the remote controller assembly.

8. Reinstall the remote controller and all door trim in the reverse order of removal. Erase any codes that were generated by the previous faulty motor assembly. Test the power sliding door for proper operation using the center overhead console switch, the B pillar switch, and the remote control button. **KIA**

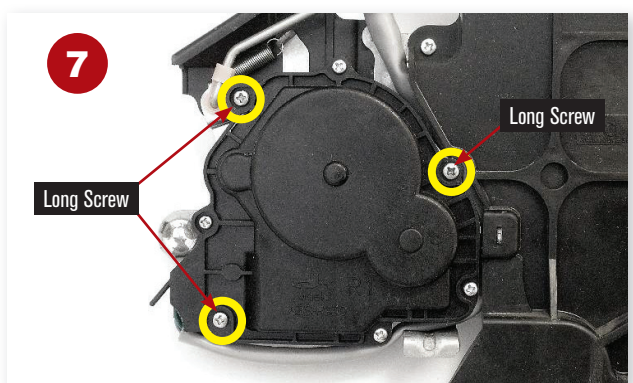

7



THE TIMING FOR SOME MAINTENANCE and repair items might be able to be stretched, but the replacement of a timing belt is not one of them.

Timing belts can last longer than their recommended service schedule; however, your customers run the risk of catastrophic engine failure if they wait too long to replace them. Most Kia vehicles have interference engines, which means if a timing belt fails the valves may hit the pistons.

Because the process of replacing a timing belt offers access to other parts, you can recommend their replacement, if appropriate. First up are the timing belt tensioners and pulleys. From there, water pump replacement is possible. And depending on a number of other factors, your recommendations can range from replacing the serpentine belt to the spark plugs.

And let's not forget about those Kias with timing chains. Generally speaking, they last longer than timing belts as long as their engines are serviced regularly. This means using the correct oil and maintaining the correct oil level for sufficient oil pressure for gears and tensioners. In the event that you have customers with high mileage Kias that may have worn and noisy timing chains, they may also need new tensioners, guides, and other associated parts.

Please refer to factory recommended maintenance schedules in the Kia owner manuals for proper service for timing chains and belts.

Whatever your customers' timing belt or timing chain needs are, Kia offers Genuine Kia Parts to keep their Kias running like Kias. Your service recommendation just may be perfect timing for them.

Contact your local Kia dealer today for assistance and delivery of your parts.

TIMING IS EVERYTHING

when it comes to replacing a timing belt



| Genuine Parts